

Research on Nonlinear Robust Control based on the Power Consumption Efficiency Model of Asynchronous Motor

Jiangyun Li and Rui Li*

School of Automation & Electrical Engineering, University of Science and Technology Beijing, Xueyuan Road 30, 100083 Beijing, China

Received: 18 May 2014, Revised: 17 Aug. 2014, Accepted: 19 Aug. 2014

Published online: 1 Mar. 2015

Abstract: This paper implements nonlinear robust control for the asynchronous motor with iron loss, derives and establishes the efficiency model for asynchronous motor with controllable power loss, and put forward to realize the accurate linearization of model with controllable power loss and high-precision tracking and control of speed and flux linkage of rotor through the state feedback precise linearization algorithm of MIMO system. The output of affine nonlinear system is tracked and controlled through the design of nonlinear robust controller. The simulation results show that with this control method energy saving control of asynchronous motor can be realized indirectly, so that the average power loss of the asynchronous motor significantly increases from 47.63% to 72.89%. This provides a reference for the design of controller of multiple input multiple output nonlinear mechanical and electrical system in the engineering.

Keywords: Asynchronous motor, controllable loss, efficiency mode, feedback linearization, nonlinear robust control

1 Introduction

In the engineering for model selection of the asynchronous motor, it is required to meet the maximum load demand, but actually most of the electric motors are in the state of light load operation. In the currently widely used variable frequency speed regulation system, the asynchronous motor generally runs within the scope of rated flux. The rated working point and efficiency of operation are obviously low. Therefore, for the asynchronous motor with long-term light load operation or a wide load change scope, there is still a great energy saving space. Motor efficiency optimization draws the wide attention of engineers and scholars. Vector control variable frequency speed regulation system has the advantages of fast response and precise control [1]. In recent years it has gradually become the mainstream control strategy of high-performance variable frequency speed regulation system [2, 3]. However, for the currently booming electric power, transportation, space electric device and other application fields, high control precision and fast dynamic response are required [4, 5, 6]. It is also

required to further improve the efficiency of the motor. This paper aims at the motor efficiency for the first time, and uses the feedback linearization method based on the differential geometric principle for control of energy consumption model of motor and designing the robust controller for the linearized system, in order to realize the goal of high-efficiency and energy-saving control of asynchronous motor.

2 Asynchronous motor controllable power loss model

The dynamic model of the asynchronous motor consists of flux-linkage equation, voltage equation, torque equation and equation of motion [7]. According to the following hypothesis:

(1) The space harmonics are ignored and three-phase winding is symmetrical. The magnetomotive force produced is distributed along the air gap according to the sine rule.

* Corresponding author e-mail: lirui01221@126.com

(2)The magnetic circuit saturation is ignored. The self-inductance and mutual inductance of the windings are constant.

From equivalent circuit of motor, as shown in Figure (1), asynchronous motor loss model is deduced.

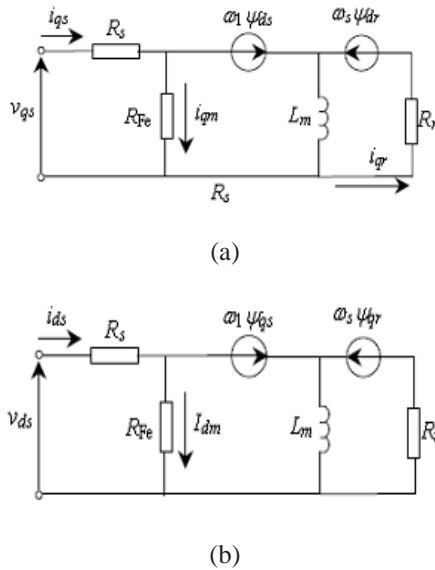

Note: v-voltage; i-current; R-resistance; ψ -flux linkage; subscript d, q-indicates variable of Axis d and Axis q respectively; subscript s, r- indicates stator and rotor variable respectively; ω_1, ω_s - synchronous rotation electrical angular frequency and slip angle frequency.

Figure 1 Steady-state equivalent circuit for asynchronous motor

In rotating d-q coordinate system, the loss of the motor is as shown in Figure (1) (a). When the asynchronous motor is in the state of steady operation, the current in the direction of d-q axis is equivalent to that of stator and rotor of the direct current motor [8]. Therefore, the induced voltage on both ends of the mutual inductance is zero. In order to simplify the analysis, the influence of the leakage inductance of the stator and rotor can be ignored. In the rotary motor model usually iron loss resistance is in parallel beside the excitation branch [9]. The leakage inductance of the rotating motor is very small, so the simplified analysis will not cause large error to the model or ignore the leakage inductance of the stator and rotor. The iron loss of the stator is represented by the loss of R_{Fe} , equivalent resistance. The magnetic chain equation is as follows:

$$\begin{cases} i_{qFe}R_{Fe} = \omega_1 \psi_{ds} = \omega_1 \psi_r \\ i_{qr}R_{Fe} = -\omega_s \psi_{dr} = -\omega_s \psi_r \end{cases} \quad (1)$$

Because the synchronous speed $\omega_1 = \omega_s + \omega_r$ and $i_{rq} = i_{qFe} - i_{sq}$, the slip angle frequency can be represented as:

$$\omega_s = \frac{R_r R_{Fe}}{R_r + R_{Fe}} \left(\frac{i_{sq}}{\psi_r} - \frac{\omega_r}{R_{Fe}} \right) \quad (2)$$

$$\sum p = p_{Cus} + p_{Cur} + p_{Fe} + p_{mech} + p_s \quad (3)$$

In which, p_{Cus} is the stator loss; p_{Cur} is the rotor copper loss; p_{Fe} is the iron loss; p_{mech} is the mechanical loss; and p_s is the stray loss.

In which, the loss controlled by adjusting the voltage is copper loss and iron loss of stator and rotor (Rotor's iron loss relative to the stator is extremely low, so the iron loss mainly refers to the iron loss of stator). After considering the oriented vector transformation in the rotor field ($\psi_{rq} = \psi_{sq} = 0$), the controllable loss studied in this paper is as follows:

$$p_{ctrl} = p_{Cus} + p_{Cur} + p_{Fe} \quad (4)$$

In Formula (4): Copper loss of the rotor:

$$p_{Cur} = i_{rq}^2 R_r = (i_{sq} R_{Fe} - \omega_r \psi_r) \frac{R_r}{(R_r + R_{Fe})^2}$$

The copper loss of the stator: $p_{Cus} = R_s (i_{sq}^2 + i_{sd}^2)$

Iron Loss: $p_{Fe} = i_{qFe}^2 R_{Fe} = \frac{\omega_1^2 \psi_r^2}{R_{Fe}}$ Substitute Formula (2) into iron loss expression of the motor, we can get:

$$p_{Fe} = \left(\frac{i_{qs} R_r + \omega_r \psi_r}{R_r + R_{Fe}} \right)^2 R_{Fe}$$

Electromagnetic torque of asynchronous motor is as follows:

$$T_e = \frac{n_p L_m}{L_r} [(i_{sq} - i_{qFe}) \psi_{rd} - (i_{sd} - i_{dFe}) \psi_{rq}] \quad (5)$$

After summarizing Formula (2) and (3), we can get the expression of loss, including electromagnetic torque:

$$p_{ctrl} = \left(R_s + \frac{R_r R_{Fe}}{R_r + R_{Fe}} \right) \left(\frac{L_r T_e}{n_p L_m \psi_r} \right)^2 + \left(\frac{R_s}{L_m^2} + \frac{R_r \omega_r^2}{R_r + R_{Fe}} \right) \psi_r^2 \quad (6)$$

Formula (6) shows that assuming that the motor parameters are unchanged, when the rotor angular frequency is a fixed value, the controllable loss of asynchronous motor is associated with the flux linkage of the rotor. It means under the condition of the stable motor output power, optimization of power consumption efficiency of the motor can be achieved by controlling the flux linkage of the rotor. The mechanical loss and stray loss are ignored there. Then we can get the energy consumption efficiency expression of asynchronous motor:

$$\eta = \frac{p_{out}}{p_{in}} = \frac{p_{out}}{p_{out} + p_{ctrl}} = \frac{\omega_r T_e}{\omega_r T_e + p_{ctrl}} = \frac{\omega_r T_e}{\left(R_s + \frac{R_r R_{Fe}}{R_r + R_{Fe}} \right) \left(\frac{L_r T_e}{n_p L_m \psi_r} \right)^2 + \left(\frac{R_s}{L_m^2} + \frac{R_r \omega_r^2}{R_r + R_{Fe}} \right) \psi_r^2 + \omega_r T_e} \quad (7)$$

When the motor has load, the motion equation is as follows:

$$\frac{J}{n_p} \frac{d\omega_r}{dt} = T_e - T_L \quad (8)$$

Obviously, the efficiency of the asynchronous motor is a function of speed and flux linkage of rotor.

Voltage equation of asynchronous motor is as follows:

$$\begin{cases} \frac{d\psi_{sd}}{dt} = -R_s i_{sd} + \omega_1 \psi_{sq} + u_{sd} \\ \frac{d\psi_{sq}}{dt} = -R_s i_{sq} - \omega_1 \psi_{sd} + u_{sq} \\ \frac{d\psi_{rd}}{dt} = -R_r i_{rd} + (\omega_1 - \omega_r) \psi_{rq} \\ \frac{d\psi_{rq}}{dt} = -R_r i_{rq} - (\omega_1 - \omega_r) \psi_{rd} \end{cases}$$

Based on Figure (1) Equivalent Circuit of Motor, loop current relationship is deducted and obtained.

$$\begin{cases} i_{dFe} = i_{sd} + i_{rd} \\ i_{qFe} = i_{sq} + i_{rq} \end{cases} \quad (9)$$

Considering the magnetic chain relationship in the Formula (1) under steady state operation, we can get $i_{dFe} = -\omega_r \psi_{sd} / R_{Fe}$.

In conclusion, we deduce and get the complete state equation of asynchronous motor with loss factor:

$$\begin{cases} \frac{d\omega_r}{dt} = \frac{n_p^2 L_m}{J L_r} [(i_{sq} - i_{qFe}) \psi_{rd} - (i_{sd} - i_{dFe}) \psi_{rq}] - \frac{n_p}{J} T_L \\ \frac{d\psi_{rd}}{dt} = -\frac{R_r R_{Fe}}{L_m (R_r + R_{Fe})} \psi_{rd} + (\omega_1 - \omega_r) \frac{R_{Fe}}{R_r + R_{Fe}} \psi_{rq} + \frac{R_r R_{Fe}}{R_r + R_{Fe}} i_{sd} \\ \frac{d\psi_{rq}}{dt} = -\frac{R_r R_{Fe}}{L_m (R_r + R_{Fe})} \psi_{rq} - (\omega_1 - \omega_r) \frac{R_{Fe}}{R_r + R_{Fe}} \psi_{rd} + \frac{R_r R_{Fe}}{R_r + R_{Fe}} i_{sq} \\ \frac{di_{sd}}{dt} = \frac{R_r R_{Fe}}{\sigma L_s L_m (R_r + R_{Fe})} \psi_{rd} + \frac{R_{Fe}}{\sigma L_s (R_r + R_{Fe})} \omega_r \psi_{rq} \\ - \left(\frac{R_s}{\sigma L_s} + \frac{R_r R_{Fe}}{\sigma L_s (R_r + R_{Fe})} \right) i_{sd} + \omega_1 i_{sq} + \frac{u_{sd}}{\sigma L_s} \\ \frac{di_{sq}}{dt} = \frac{R_r R_{Fe}}{\sigma L_s L_m (R_r + R_{Fe})} \psi_{rq} - \frac{R_{Fe}}{\sigma L_s (R_r + R_{Fe})} \omega_r \psi_{rd} \\ - \left(\frac{R_s}{\sigma L_s} + \frac{R_r R_{Fe}}{\sigma L_s (R_r + R_{Fe})} \right) i_{sq} - \omega_1 i_{sd} + \frac{u_{sq}}{\sigma L_s} \end{cases} \quad (10)$$

In which, J is the rotational inertia of the motor; the magnetic flux leakage coefficient of motor $\sigma = 1 - \frac{L_m^2}{L_s L_r}$.

Selection state variable

$$\mathbf{X} = [x_1 \ x_2 \ x_3 \ x_4]^T = [\omega_r \ \psi_{rd} \ i_{sd} \ i_{sq}]^T$$

, input variable $\mathbf{U} = [u_{sd} \ u_{sq}]^T$, and output variable $\mathbf{Y} = [\psi_r \ \omega_r]^T$, This paper mainly studies the steady state of motor and the rotor of cage asynchronous motor has short circuit inside, so $u_{rd} = u_{rq} = 0$. The torque equation of the system is as shown in Formula (5). Formula (10) is converted into a four-order nonlinear system [10]:

$$\begin{cases} \dot{x}_1 = A(x_2 x_4 - B x_2^2) - C \\ \dot{x}_2 = \frac{D}{L_m} x_2 + D x_3 \\ \dot{x}_3 = E x_2 - G x_3 + \omega_1 x_4 + \frac{u_{sd}}{\sigma L_s} \\ \dot{x}_4 = -F x_1 x_3 - G x_4 - \omega_1 x_3 + \frac{u_{sq}}{\sigma L_s} \end{cases} \quad (11)$$

In Formula(11),

$$\begin{aligned} A &= \frac{n_p^2 L_m}{J L_r}; B = \frac{\omega_1}{R_{Fe}}; C = \frac{n_p}{J} T_L; \\ D &= \frac{R_r R_{Fe}}{R_r + R_{Fe}}; E = \frac{R_r R_{Fe}}{\sigma L_s L_m (R_r + R_{Fe})}; F = \frac{R_{Fe}}{\sigma L_s (R_r + R_{Fe})}; \\ G &= \frac{R_s}{\sigma L_s} + \frac{R_r R_{Fe}}{\sigma L_s (R_r + R_{Fe})}; H = \frac{1}{\sigma L_s} \end{aligned}$$

Output function of the selection system:

$$y = [h_1(x) \ h_2(x)]^T = [\psi_r \ \omega_r]^T = [x_2 \ x_1]^T$$

Then we get the affine model of AC asynchronous motor with loss as follows:

$$\begin{cases} \dot{x} = f(x) + g(x)u \\ y = h(x) \end{cases} \quad (12)$$

In which,

$$f(x) = \begin{bmatrix} A(x_2 x_4 - B x_2^2) - C \\ \frac{D}{L_m} x_2 + D x_3 \\ E x_2 - G x_3 + \omega_1 x_4 \\ -F x_1 x_3 - G x_4 - \omega_1 x_3 \end{bmatrix}$$

$$g(x) = \begin{bmatrix} 0 & 0 \\ 0 & 0 \\ H & 0 \\ 0 & H \end{bmatrix}$$

3 MIMO system state feedback exact linearization

First, calculate the sub relation degree corresponding to each output function in the system[11].

Definition 1: For the single input and single output system

$$\begin{cases} \dot{x} = f(x) + g(x)u \\ y = h(x) \end{cases}$$

the value of k-order Lie derivative to vector field f and Lie derivative to vector field g of the output function h is zero in the field of $x = x^0$; and the value of r-1 order Lie derivative to f and Lie derivative to g of h is not zero in the field of $x = x^0$. Then the relation degree of affine nonlinear system in the field of x^0 is r.

Definition 2: The relation degree of multiple input multiple output affine nonlinear system is a set. It means each output function h_i has a sub relation degree r_i . The set of system relation degree with m output functions is denoted by $r = \{r_1, r_2, \dots, r_m\}, i = 1, 2, \dots, m$. The sub relation degree r_i must meet the following conditions: r_i corresponds to Lie derivative set of p inputs of the system: In

$\{L_{g_1} L_f^{r_i-1} h_i(x), L_{g_2} L_f^{r_i-1} h_i(x), \dots, L_{g_p} L_f^{r_i-1} h_i(x)\}$, not all the factors are zero. For the set of positive integer $k < r_i$, in $\{L_{g_1} L_f^k h_i(x), L_{g_2} L_f^k h_i(x), \dots, L_{g_p} L_f^k h_i(x)\}$ all the factors are zero.

According to Definition 1, Lie derivative of the system is calculated, in order to get each sub relation degree of System (5):

$$\begin{cases} L_{g_1} L_f^0 h_1(x) = 0 \\ L_{g_2} L_f^0 h_1(x) = 0 \end{cases}$$

$$\begin{cases} L_{g_1}L_f^1 h_1(x) = DH \\ L_{g_2}L_f^1 h_1(x) = 0 \end{cases}$$

When $r_1 - 1 = 1$, $h_1(x)$ is not all 0 relative to the Lie derivative input, so $r_1 = 2$.

$$\begin{cases} L_{g_1}L_f^0 h_2(x) = 0 \\ L_{g_2}L_f^0 h_2(x) = 0 \end{cases}$$

$$\begin{cases} L_{g_1}L_f^1 h_2(x) = 0 \\ L_{g_2}L_f^1 h_2(x) = AHx_2 \end{cases}$$

When $\psi_r \neq 0$ and $r_2 - 1 = 1$, is not all 0 relative to the Lie derivative input, so $r_2 = 2$.

From Definition 2, we can get the relation degree set of the system: $r = \{r_1, r_2\} = \{2, 2\}$.

Theorem 1: Assume that matrix $g(x^0)$ has rank m , then the state space exact linearization problem has a solution. When and only when field U of x^0 and m real functions of $h_1(x), \dots, h_m(x)$ defined on U exist, the n -order affine nonlinear system

$$\begin{cases} \dot{x} = f(x) + g(x)u \\ y = h(x) \end{cases}$$

has relation degree $r = \{r_1, r_2, \dots, r_m\}, i = 1, 2, \dots, m$ at x^0 and $\sum_{i=1}^m r_i = n$.

According to Theorem 1, $r_1 + r_2 = 4 = n$, so the original system (0000) can be accurately linearized[12].

In conclusion, when $is_d \neq 0$ and $L_m^2 \neq L_s L_r$, $B(x) =$

$$\begin{bmatrix} L_{g_1}L_f^{r_1-1} h_1(x) & L_{g_2}L_f^{r_1-1} h_1(x) \\ L_{g_2}L_f^{r_2-1} h_2(x) & L_{g_2}L_f^{r_2-1} h_2(x) \end{bmatrix}$$

is singular matrix.

System order number $n=4$. The input number of controlled variables $m=2$. According to the index number election criteria $m \geq n_1 \geq n_2 \dots \geq n_N, \sum_{i=1}^N n_i = n$, select appropriate index number: $n_1 = m = 2$ and $n_2 = 2$, i.e. $N=2$.

Step1: Form n vector field sets:

$$\begin{cases} D_1 = \{g_1\} \\ D_2 = D_m = \{g_1, g_2\} \\ D_3 = D_{m+1} = \{g_1, g_2, ad_f g_1\} \\ D_4 = D_{m+n_2} = \{g_1, g_2, ad_f g_1, ad_f g_2\} \end{cases}$$

Definition 3: If for k n -dimensional vector fields

$$\begin{bmatrix} g_{11} & g_{21} & \dots & g_{k1} \\ g_{12} & g_{22} & \dots & g_{k2} \\ \vdots & \vdots & \ddots & \vdots \\ g_{1n} & g_{2n} & \dots & g_{kn} \end{bmatrix}$$

rank at Point $x = x^0$ is k , for each pair of integer I and $j, 1 \leq i, j \leq k$, and rank of the augmented matrix $[g_1 \ g_2 \ \dots \ g_k \ [g_i, g_j]]$ at Point $x = x^0$ is still k , then the

vector field set is involutory. Space $span\{g_1 \ g_2 \ \dots \ g_k\}$ is known as involutory distribution.

After the calculation, $D_1 \dots D_4$ are involutory.

Theorem 2: For MIMO affine nonlinear system $\dot{x} = f(x) + \sum_{i=1}^m g_i(x)u_i$, choose the index number

$m = n_1 \geq n_2 \geq \dots \geq n_N, \sum_{i=1}^N n_i = n$. n is the system dimension. If the following two points are meet, the system can be transformed into fully controllable Brunovsky standard on an open set of $x = x^0$ through state feedback:

$$D_n = [g_1 \ \dots \ g_{n_1}, ad_f g_1 \ \dots \ ad_f g_{n_2}, ad_f^{N-1} g_1 \ \dots \ ad_f^{N-1} g_{n_N}]$$

is non-singular in the domain of definition;

In the vector field set:

$$\begin{cases} D_1 = \{g_1\} \dots D_{n_1} = \{g_1 \ \dots \ g_{n_1}\} \\ \vdots \\ D_{n_1+1} = \{D_{n_1}; ad_f g_1\} \dots D_{n_1+n_2} \\ = \{D_{n_1}; ad_f g_1 \ \dots \ ad_f g_{n_2}\} \\ \vdots \\ D_n = \{D_{n-n_N}; ad_f^{N-1} g_1 \ \dots \ ad_f^{N-1} g_{n_N}\} \end{cases}$$

Every vector field is involutory.

On the basis of Theorem 2, examine Matrix D :

$$\begin{aligned} D_{n \times n} &= [g_1, g_2, ad_f g_1, ad_f g_2] \\ &= \begin{bmatrix} 0 & 0 & 0 & -AHx_2 \\ 0 & 0 & -DH & 0 \\ H & 0 & GH & -H\omega_1 \\ 0 & H & H(\omega_1 + Fx_1) & GH \end{bmatrix} \end{aligned}$$

After elementary transformation: $D_{n \times n} \rightarrow I_4$, i.e. $D_{n \times n}$ has full rank.

So we can determine for the original affine nonlinear system exact linearization can be achieved via state feedback.

Step2: Select n linear independent vector fields

$\bar{D}_i \in D_i(x)$ and $i=1 \dots n$. \bar{D}_i shall be as simple as possible, so we choose unit matrix:

According to the formula:

$$\begin{aligned} \bar{D}_n + \sum_{j=1}^m k_j^{(n)}(x)g_j(x) + \sum_{j=1}^{n_2} k_{m+j}^{(n)}(x)ad_f g_j(x) \\ + \dots + \sum_{j=1}^{n_N} k_{m+\dots+n_{N-1}+j}^{(n)}(x)ad_f^{N-1} g_j(x) = 0 \end{aligned} \quad (13)$$

Make $k_1^{(2)} = x_1$; $k_1^{(1)} = x_1, k_2^{(1)} = x_2$; and $k_1^{(4)} = x_1, k_2^{(4)} = x_2, k_3^{(4)} = x_3$, solve the function by recurrence:

$$\begin{aligned} k_1^{(2)} &= -\bar{D}_1/g_1 \\ k_2^{(2)} &= -(\bar{D}_2 + k_1^{(2)}g_1)/g_2 \\ k_3^{(3)} &= -(\bar{D}_3 + k_1^{(3)}g_1 + k_2^{(3)}g_2)/ad_f g_1 \\ k_4^{(4)} &= -(\bar{D}_4 + k_3^{(4)}ad_f g_1 + k_1^{(4)}g_1 + k_2^{(4)}g_2)/ad_f g_2 \end{aligned}$$

Step3: Deduce the mapping relationship between different coordinate systems.

From the integral curve obtained of vector field $\bar{D}_1 \cdots \bar{D}_n$, deduce the mapping relationship between state space R^n indicated with the new coordinate w and the state space originally with x as the coordinate:

$$F(w_1, \dots, w_n) = \Phi_{\omega_1}^{\bar{D}_1} \circ \dots \circ \Phi_{\omega_n}^{\bar{D}_n}(x) \tag{14}$$

Beginning from \bar{D}_n , by the recursive relation:

$$\frac{d}{dw_{n-1}} [x_1, \dots, x_n]^T = \bar{D}_{n-1}, x(0) = \Phi_{\omega_n}^{\bar{D}_n} \tag{15}$$

Solve the differential equations one by one to get the desired mapping $x = F(w)$:

$$\begin{cases} x_1 = w_1 \\ x_2 = w_2 + 1 \\ x_3 = w_3 \\ x_4 = w_4 \end{cases}$$

Accordingly, the inverse mapping of $F w = F^{-1}(x)$ is

$$\begin{cases} w_1 = x_1 \\ w_2 = x_2 - 1 \\ w_3 = x_3 \\ w_4 = x_4 \end{cases}$$

Step4: Obtain the induced mapping.

Definition 4: For a differential homeomorphism coordinate mapping $\Phi : z = \Phi(x)$ and a vector field $f(x)$ in space, J_Φ indicates Jacobian matrix of $\Phi(x)$. The induced mapping of $f(x)$ under space mapping $\Phi(x)$ is $\Phi_*(f) = J_\Phi(x)f(x)|_{x=\Phi^{-1}(z)}$.

According to Definition 4, the inverse mapping $w = F^{-1}(x)$ obtained is considered as a space mapping to get induced mapping $F_*^{-1}(x) = J_{F^{-1}}f(x)$ of the original system function $f(x)$. Substitute $x = F(w)$ into the induced mapping to get the new mapping. It is denoted by $f^{(0)}(w)$. In which, $J_{F^{-1}}$ is the Jacobian matrix of $F^{-1}(x)$.

$$f^{(0)}(w) = \begin{bmatrix} Aw_4(w_2 + 1) - AB(w_2 + 1)^2 - C \\ Dw_3 - D(w_2 + 1)/L_m \\ \omega_1 w_4 - Gw_3 + E(w_2 + 1) \\ -Gw_4 - \omega_1 w_3 - Fw_1 w_3 \end{bmatrix} \tag{16}$$

To obtain coordinate transformation and state feedback, define the intermediate transformation

$R_j, j=1, \dots, N-1$. The relational expression of $R_j; j = 1, \dots, N-1$.

$$z_i^{(j)} = \begin{cases} f_{n_j+i}^{(j-1)}(w) & i = 1, \dots, n-n_j \\ z_i^{(j-1)} = \omega_i & i = n-n_j+1, \dots, n \end{cases} \tag{17}$$

In Formula (10) $f^{(j)}(w) = J_{R_j}(w)f^{(j-1)}(w)$

From Formula $f^{(0)}(w)$, we can get:

$$R_1 = \begin{bmatrix} \omega_1 w_4 - Gw_3 + E(w_2 + 1) \\ -Gw_4 - \omega_1 w_3 - Fw_1 w_3 \\ w_3 \\ w_4 \end{bmatrix} \tag{18}$$

Because the system studied in this paper has $N=2$, transforming of R_1 is to ultimately get the coordinate transformation from Space w to Space z . From Definition 4, compound transformation is $T \triangleq R_{N-1}F^{-1}|_{w=F^{-1}(x)}$. Under the effect of the compound coordinate transformation, the vector field of the original system is transformed into $\tilde{f}(x)$ and $\tilde{g}(x)$, i.e. $\tilde{f}(x) = J_T(x)f(x)$ and $\tilde{g}(x) = J_T(x)g(x)$.

Step5: Induce Brunovsky standard and calculate the control law[13].

According to the above, obtain the coordinate transformation and make $z = \tilde{f}(x)$:

$$\begin{cases} z_1 = w_3(x) \\ z_2 = w_4(x) \\ z_3 = \tilde{f}_4(x) \\ z_4 = \tilde{f}_3(x) \end{cases} \tag{19}$$

The original radiation nonlinear system can be transformed into Brunovsky standard:

$$\begin{cases} \dot{z}_1 = z_3 \\ \dot{z}_2 = z_4 \\ \dot{z}_3 = v_1 \\ \dot{z}_4 = v_2 \end{cases} \tag{20}$$

By inverse mapping $x = \tilde{f}^{-1}(z)$, we can get the state feedback control law of the original nonlinear system [14]:

$$u = -b^{-1}(x)a(x) + b^{-1}(x)v \tag{21}$$

In which, $v = [v_1, v_2, \dots, v_m]^T$

$$\begin{aligned} a(x) &= [\tilde{f}_1, \dots, \tilde{f}_m]^T \\ &= \begin{bmatrix} E(Dx_3 - Dx_2)/L_m - \\ G(Ex_2 - Gx_3 + \omega_1 x_4) - \omega_1(Gx_4 + \omega_1 x_3 + Fx_1 x_3) \\ G(Gx_4 + \omega_1 x_3 + Fx_1 x_3) - \\ (\omega_1 + Fx_1)(Ex_2 - Gx_3 + \omega_1 x_4) + Fx_3(ABx_2^2 - Ax_4 x_2 + C) \end{bmatrix} \end{aligned} \tag{22}$$

$$\begin{aligned}
 b(x) &= \begin{bmatrix} \tilde{g}_{11} & \tilde{g}_{21} & \cdots & \tilde{g}_{m1} \\ \tilde{g}_{12} & \tilde{g}_{22} & \cdots & \tilde{g}_{m2} \\ \vdots & \vdots & & \vdots \\ \tilde{g}_{1m} & \tilde{g}_{2m} & \cdots & \tilde{g}_{mm} \end{bmatrix} \\
 &= \begin{bmatrix} -GH & H\omega_1 \\ -H(\omega_1 + Fx_1) & -GH \end{bmatrix}
 \end{aligned} \tag{23}$$

4 Design of nonlinear robust controller

As described earlier, through the state nonlinear robust control method we have got the linearization system of the nonlinear system in the new coordinate space z [15]. Define disturbance vector s for the linear system. It means the Brunovsky standard with interference factors is as follows:

$$\begin{cases} \dot{z} = A_z z + B_{1z} s + B_{2z} v \\ z = C_z z \end{cases} \tag{24}$$

$$A_z = \begin{bmatrix} 0 & 0 & 1 & 0 \\ 0 & 0 & 0 & 1 \\ 0 & 0 & 0 & 0 \\ 0 & 0 & 0 & 0 \end{bmatrix} \quad B_{z1} = \begin{bmatrix} 1 & 0 \\ 0 & 1 \\ 0 & 0 \\ 0 & 0 \end{bmatrix}$$

$$B_{z2} = \begin{bmatrix} 0 & 0 \\ 0 & 0 \\ 1 & 0 \\ 0 & 1 \end{bmatrix} \quad C_z = \begin{bmatrix} 1 & 0 & 0 & 0 \\ 0 & 1 & 0 & 0 \end{bmatrix}$$

The linear system after decoupling is as shown in the figure below:

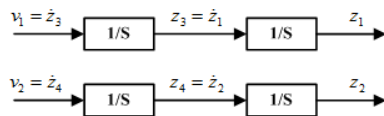

Figure 2 Decoupled linear system of the Brunovsky standard form

After system linearization, the nonlinear factors have been mapped to the input signal u . If we investigate the dynamic performance of system input and output from the outside of system, we need to complete the design of tracking and control. Whether the output signal of the system is able to more quickly meet the set reference trajectory is an important index to control the system. For example, to track the reference trajectory z_{ref} of a second order independent part in the system, the stable pole of linear system is required to meet the Hurwitz criterion. Input the calculation formula v :

$$v = \ddot{z}_{ref} + k_1(\dot{z}_{ref} - \dot{z}) + k_2(z_{ref} - z) \tag{25}$$

In which the coefficient k meets Hurwitz' polynomial $s^2 + k_1s + k_2 = 0$.

Below according to the H_∞ method, calculate the robust pre-feedback v^* of linear system, map v^* to the

original affine nonlinear system, and get the nonlinear control strategy u^* [16]. According to the linear robust control theory, the robust control problem of System (20) can be equivalent to the mathematical problem of solving Raccati matrix inequation. It means the sufficient condition of robust control problem with solution is when and only when Raccati inequation has nonnegative solution P^* :

$$A_z^T P + P A_z + P \left(\frac{1}{\gamma^2} B_{1z} B_{1z}^T - B_{2z} B_{2z}^T \right) P + C_z^T C_z < 0 \tag{26}$$

In which, $\gamma > 0$ is the L_2 gain of given interference for the output. In general, the smaller γ is, the stronger anti-interference ability the robust controller has. Its optimal value can be obtained with the variational method. If nonnegative solution is obtained, it shows that for the linear system the most serious possible interferences $s^* = -\frac{1}{\gamma^2} B_{1z}^T P^* z$ has optimal control law:

$$v^* = -B_{1z}^T P^* z = -K^* z \tag{27}$$

From the mapping relation of $z = \tilde{f}(x)$, we can get the optimal control rules in Space x .

$$\begin{aligned}
 u^* &= -b^{-1}(x)a(x) + b^{-1}(x)v^* \\
 &= -b^{-1}(x)a(x) - K^* z b^{-1}(x)
 \end{aligned} \tag{28}$$

From the perspective of differential game theory, we can prove that Formula (28) is also the robust control law of the original affine nonlinear system (12).

5 Simulation test

(1)According to the design principle of feedback tracking controller, and the nonlinear robust control law obtained above, set the specified output signal and the initial value: $y1_{ref} = \sin(10\pi t) + 5, y1(0) = 0, y2_{ref} = 20t + \sin(100\pi t), y2(0) = 0.1$. Test the feedback control model of AC asynchronous motor. Set the simulation time $t=1s$, and simulate gradually increased load in this period and the change of the electromagnetic torque of motor output. The simulation parameters are as follows: rated power of 2.2(kVA), rated frequency of $f_n=50(Hz), R_{Fe}=0.16\Omega; L_m=0.258(H); L_r=0.27(H); L_s=0.27(H); R_s=0.85\Omega; R_r=0.81\Omega; J=0.31(kg.m^2)$; and pole pairs of $n_p = 2$.

Prior to adding the robust controller, only by output feedback control, the system frequency tracking is normal, but gain output is diverging, as shown in the figure below:

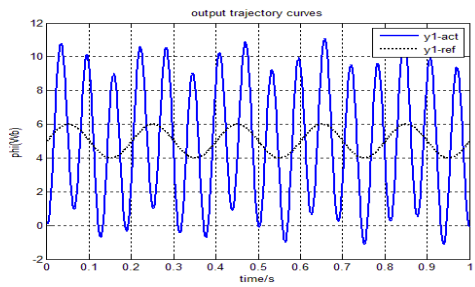

(a)Speed output of the motor

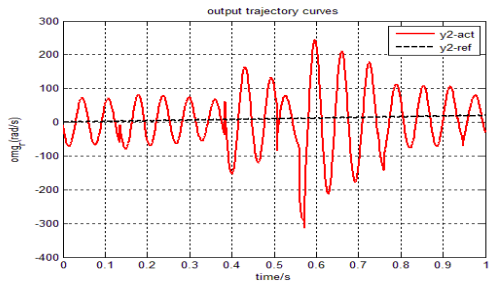

(b)Flux linkage output of motor rotor

Figure 3 Feedback tracking simulation of output signal

After adding the nonlinear robust controller, the output signal can fast converge simulation results, as shown in Figure 3.

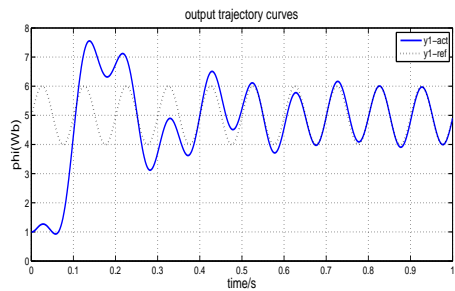

(a)Speed output of nonlinear robust control motor

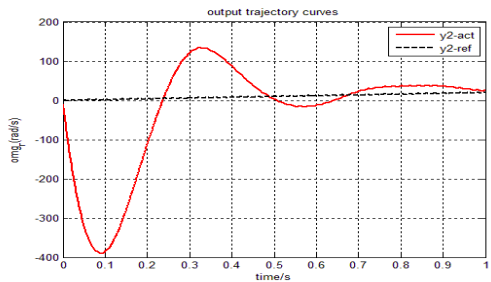

(b)Flux linkage output of rotor of nonlinear robust control motor

Figure 4 Tracking simulation of nonlinear robust control output signal

Experimental results show that under the action of the nonlinear control law u , the output signal y_{act} of the system can track the reference signal y_{ref} after a brief adjustment process. And through the nonlinear robust control method, the two output variables are completely decoupled.

(2)The control results of electromagnetic torque and motor efficiency are tested. The motor parameters are unchanged.

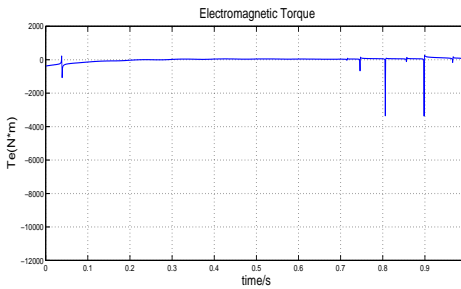
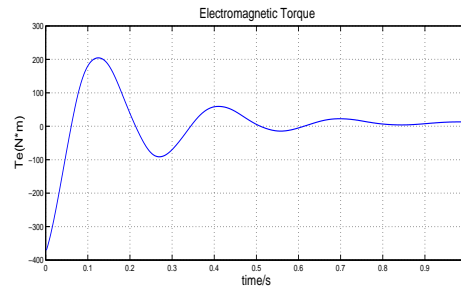

(a)Electromagnetic torque of the motor

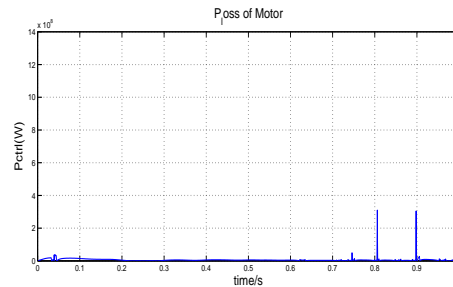
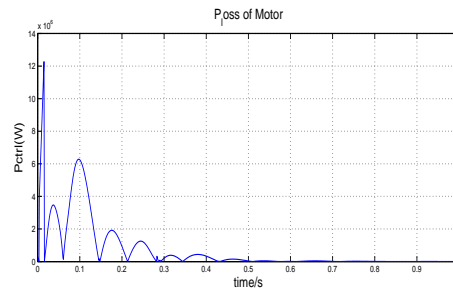

(b)Controllable power loss

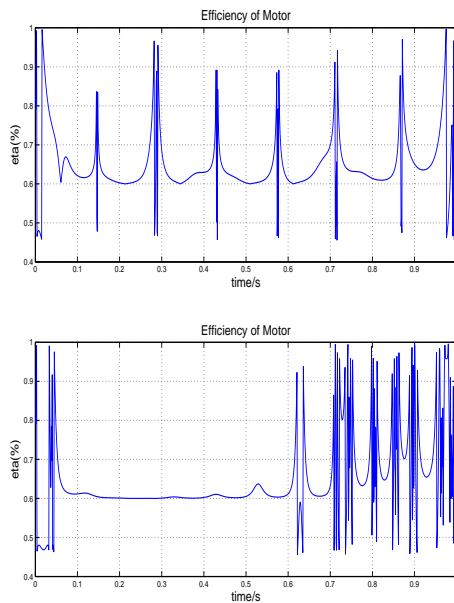

(c) Real-time efficiency of the motor

Figure 5 Comparison of motor output and efficiency before and after adding the nonlinear robust controller

Experimental results show that after the adjustment of nonlinear robust controller, the output torque of asynchronous motor can be stably converged. The energy efficiency of the motor is obviously improved. The statistics show that the average loss increases from 47.63% to 72.89%, and the adjustment of output electromagnetic torque and controllable power loss rapidly becomes stable.

6 Conclusion

In this paper, nonlinear robust control is implemented for the asynchronous motor with the iron loss. Results show that through state feedback exact linearization algorithm of MIMO system, the accurate linearization of affine nonlinear motor model and the dynamic decoupling of output variable can be realized, so as to realize the high accuracy tracking and control of speed and flux linkage of rotor. This paper gives the detailed deduced loss motor model, and gives the exact linearization theoretical derivation process of multiple input multiple output nonlinear system, and designs the nonlinear robust feedback controller. Test results show that the nonlinear robust controller has good control effect of electromagnetic torque. The average power loss of asynchronous motor significantly increases from 47.63% to 72.89%. By the design method in this paper, we can make the whole system run stably. Although the control law has the complex nonlinear feature, for the similar nonlinear mechanical and electrical system realizing energy saving control with this control method is completely feasible.

Acknowledgement

The authors gratefully acknowledge the support by Program for New Century Excellent Talents in Universities (NCET-11-0578), National Natural Science Foundation of China (Grant No. 61074055), the Fundamental Research Funds for the Central Universities (No. FRF-SD-12-008B) and Specialized Research Fund for the Doctorial Program of Higher Education (No.20130006110008).

The authors are grateful to the anonymous referee for a careful checking of the details and for helpful comments that improved this paper.

References

- [1] D.Joshi, M.Gill, Comparison of Vector Control Techniques for Induction Motor Drive[J]. *Indian Journal of Electrical and Biomedical Engineering*, **1**, 17-27 (2013).
- [2] J.Gu, M.Ouyang, D.Lu, et al. Energy efficiency optimization of electric vehicle driven by in-wheel motors[J]. *International Journal of Automotive Technology*, **14**, 763-772 (2013).
- [3] J.Navardi, B.Babaghorbani, A.Ketabi, Efficiency improvement and torque ripple minimization of Switched Reluctance Motor using FEM and Seeker Optimization Algorithm[J]. *Energy Conversion and Management* **78**, 237-244 (2014).
- [4] S.Y.Sim, W.M.Utomo, Z.A.Haron, et al, Induction Motor Drive Based Neural Network Direct Torque Control[M], *Information Technology Convergence*. Springer Netherlands, 255-262 (2013).
- [5] W.Y.Choi, High-efficiency dcCdc converter with fast dynamic response for low-voltage photovoltaic sources[J], *Power Electronics, IEEE Transactions on* **28**, 706-716 (2013).
- [6] S.C.Agarlita, C.E.Coman, G.D.Andreescu, et al, Stable V/f control system with controlled power factor angle for permanent magnet synchronous motor drives[J], *IET Electric Power Applications* **7** 278-286 (2013).
- [7] M.Lv, Mathematical Modeling and Simulation Analysis on Speed Control System of Asynchronous Motor Based on Vector Frequency Conversion Technology[C], *Digital Manufacturing and Automation (ICDMA), 2013 Fourth International Conference on*. IEEE, 770-772 (2013).
- [8] N.Fki, G.Clerc, P.Velex, Gear and motor fault modeling and detection based on motor current analysis[J], *Electric Power Systems Research* **95**, 28-37 (2013).
- [9] M.Schubert, S.Koschik, R.W.Doncker.De, Fast optimal efficiency flux control for induction motor drives in electric vehicles considering core losses, main flux saturation and rotor deep bar effect[C], *Applied Power Electronics Conference and Exposition (APEC), 2013 Twenty-Eighth Annual IEEE*. IEEE, 811-816 (2013).
- [10] M.Y.Li, B.Y.Wang, Q.F.Yan, et al, Modeling and Simulation of Asynchronous Motor in Coordinate System Based on Matlab[J], *Advanced Materials Research* **756**, 4646-4651 (2013).
- [11] M.A.Mahmud, H.R.Pota, M.Aldeen, et al, Partial feedback linearizing excitation controller for multimachine power systems to improve transient stability[J] (2013).

- [12] J.Arif, S.Ray, B.Chaudhuri, MIMO feedback linearization control for power systems[J], International Journal of Electrical Power and Energy Systems **45**, 87-97 (2013).
- [13] H.Chaozhi, L.Hong, X.Fayuan, State Variable Feedback Linearization Control of 3-phase Integrating Magnetic Voltage Regulator Model[C], Measuring Technology and Mechatronics Automation (ICMTMA), 2011 Third International Conference on. IEEE **3**, 334-337 (2011).
- [14] G.A.O.De-Xin, Y.Xiao-Yan, C.Bao-Tong, Feedback linearization optimal disturbances rejection approach of bilinear systems[C], Control Conference (CCC), 2011 30th Chinese, IEEE, 359-363 (2011).
- [15] O.U.Rehman, B.Fidan, I.R.Petersen, Uncertainty modeling and robust minimax LQR control of multivariable nonlinear systems with application to hypersonic flight[J], Asian Journal of Control **14** 1180-1193 (2012).
- [16] H.Zhang, Y.Shi, A.S. Mehr, Robust PID control for multivariable networked control systems with disturbance/noise attenuation[J], International Journal of Robust and Nonlinear Control **22**, 183-204 (2012).
-



models for complex systems, control theory and engineering for rolling equipment. He is also interested in Application of machine vision in the field of metallurgy industry.



geometry and applications in nonlinear control system ,and active disturbance rejection control and applications in electrical drive system.

Jianguyun Li is Associate Professor of University of Science and Technology Beijing, working in School of Automation & Electrical Engineering. His research interests are in the areas of Metallurgical Industry Automation including the mathematical methods and

Rui Li is doctoral student in major of control theory and engineering ,since 2011, pursuing his PhD degree at School of Automation & Electrical Engineering, university of Science and Technology Beijing. China. His research interests are in the areas of differential